

## INTRIGO 710 SOUS PLAN



Kitchen Sinks

Code: N457 S40

VASCA INTRIGO mm 710x400 R12 SOUSPLAN



### DETAILS

Edge/Installation Type	Undermount
Material	AISI 304 stainless steel
Texture	Foster brushed
Base	80 cm
Dimensions	750 x 440 mm
Standard fittings	Fixing hooks, gasket, drain, overflow and siphon, boxed packing
Mixer holes	No standard holes
Built-in hole	View technical data sheet
Drainer	No

Width 75 cm

---

Bowl dimension 710 x 400 mm

---

Number of bowls 1 bowl

---

Waste fitting Drain SPACE 3,5"

---

Notes: As the product consists of a single seamless steel surface with no gaps or interstices, the use of garbage disposal and waste fitting with automatic control is not permitted.

---

## FEATURES

**ONE SEAMLESS STEEL SURFACE** The waste-fitting and overflow are moulded on the sink. The product is therefore made out of one seamless steel surface, without gaps or interstices. A great plus in terms of hygiene.

---

**Deep bowls** This bowls reach an important depth, over 20 cm, thanks to the advanced production technology, that can be offer great capiciency and practicity in all the washing operations.

---

**High thickness** 1mm thick steel. A significant thickness, which guarantees the maximum sturdiness and durability.

---

**Perimetral overflow** The overflow is always a security on the Foster sinks that prevents the overflow of water in case of oversights. The perimeter drain solution improves aesthetics thanks to its square and essential shape.

---

**Save space system** Drain and siphon are designed to leave as much space as possible in the under-sink area, more and more useful today for theseparate waste collection systems.

---

**Small radius** Bowls with squared shapes with a modern design and an increased capacity, for a minimal aesthetics connected with an extreme practicity.

---

**Space waste fitting** The elegant SPACE steel cap closes the drain and leaves no visible residues collected in the basket below. Space also has a small footprint and allows the optimal use of the under-sink compartment.

---

## TECHNICAL DATA

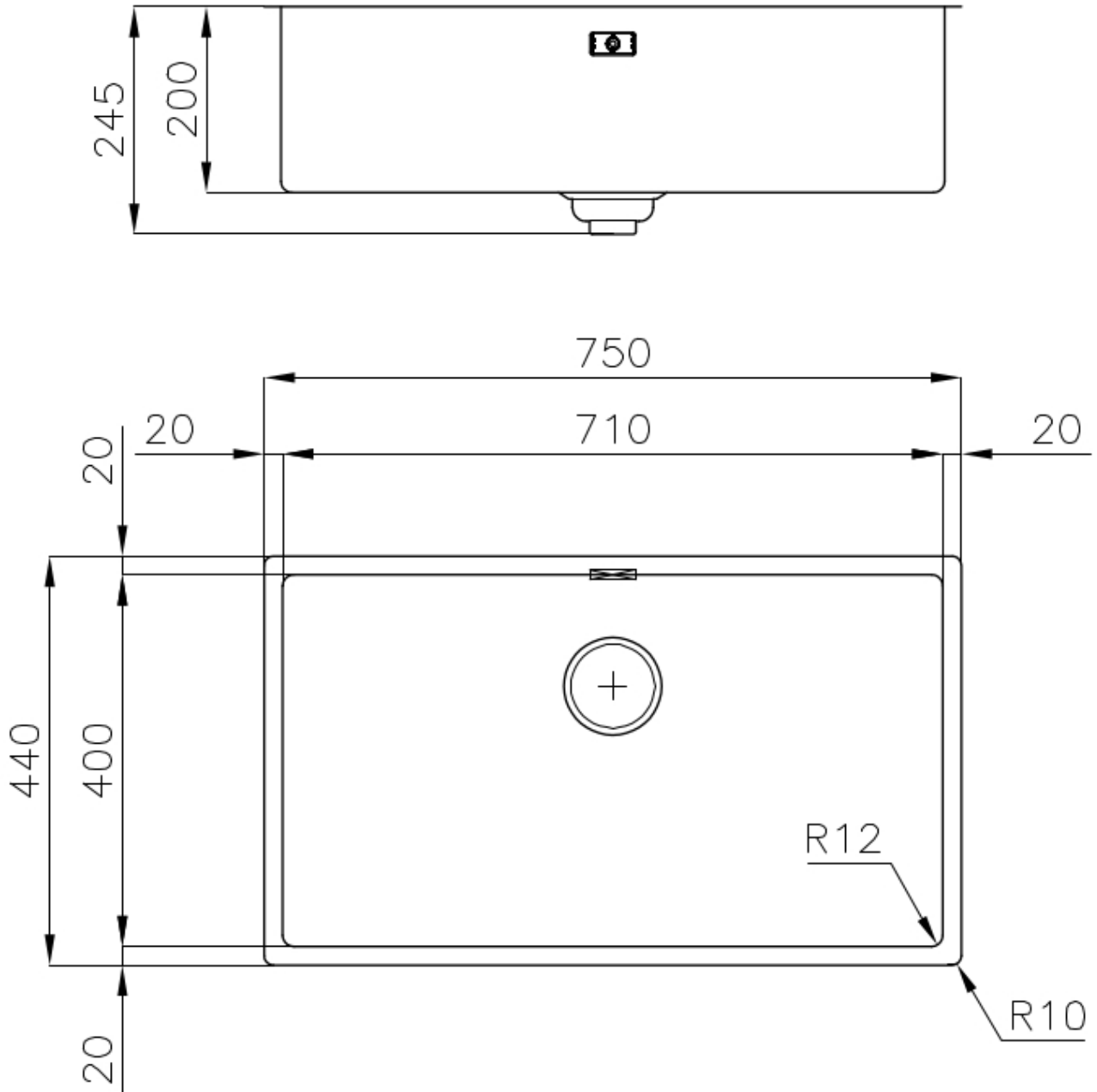

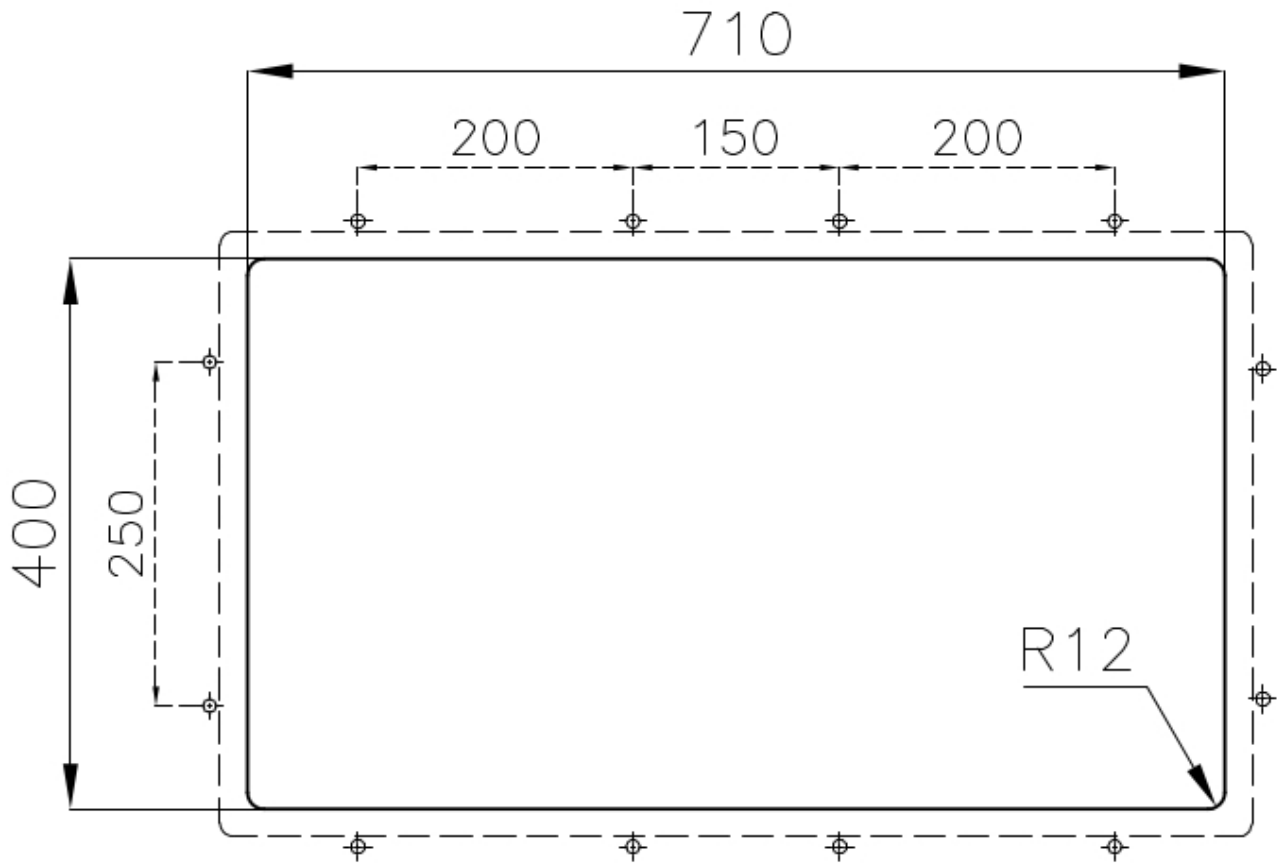

## GALLERY

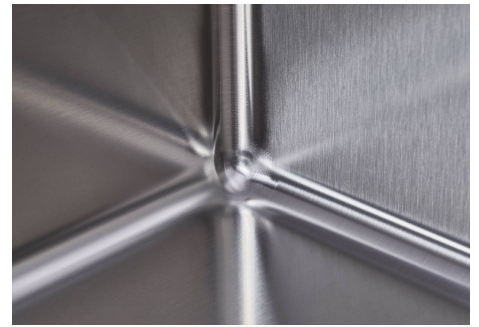

## OPTIONAL ACCESSORIES



**CUVETTE PERFOREE INOX**

A154 F00

\* only in combination with the accessory  
A644 F04



**CUVETTE PLASTIQUE BLANCHE**

A153 A00

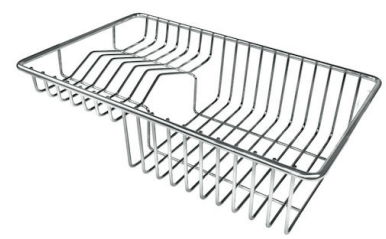

**GRILLE POR.ASSIETTES INOX**

**mm214x379**

A100 C03

\* only in combination with the accessory  
A644 A01



**GRILLE PORTE-ASSIETTES INOX**

**250x425**

A100 B01



**GRILLE PORTE-ASSIETTES INOX**

**25x35**

A100 A54

\* only in combination with the accessory  
A644 F04



**PLANCHE DE DECOUPE CRYSTAL**

**23x41 CM**

A631 C00



**PLANCHE DE DECOUPE DOUBLE  
HDPE**  
A644 A01



**PLANCHE DE DECOUPE DOUBLE  
IROKO**  
A644 F04



**CUVETTE INOX PERFOREE**  
A151 F00  
\* only in combination with the accessory  
A644 A01



**KIT RÂPES ET PLANCHE DE  
DECOUPE HDPE**  
A159 A01  
\* only in combination with the accessory  
A644 A01



**PANIER INOX POUR CUVE 34x40  
CM**  
A611 F00



**PLANCHE DE DECOUPE DOUBLE  
IROKO**  
A644 F44

## RECOMMENDED PAIRINGS



**INCISO**  
R424 A00